



**Nota:**

- Comprobar el buen estado de la cubierta y la capacidad portante de la misma
- Comprobar la impermeabilidad de la fijación una vez colocada

Soporte inclinado abierto para cubierta plana.  
Horizontal.

**09H**

**SUNFER**

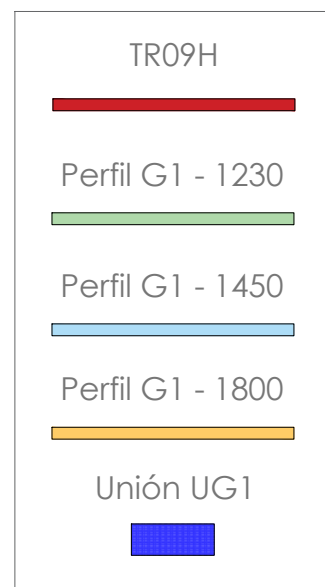
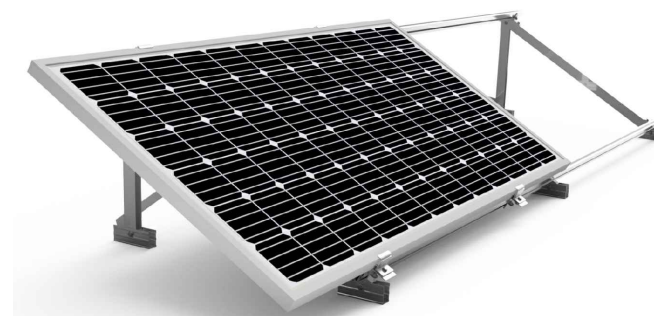

**Par de apriete:**

Tornillo Presor	7 Nm
Tornillo M8 Hexagonal	20 Nm
Tornillo M10 Hexagonal	40 Nm
Tornillo M6.3 Hexagonal	10 Nm
Tornillo M4.2/4.8 Hexagonal	6 Nm

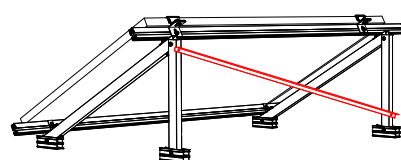

Arriostramiento 2 triángulos

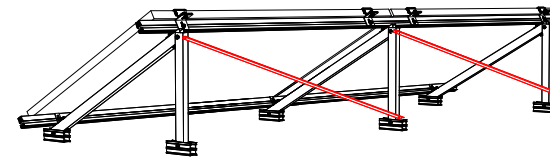

Arriostramiento 3 triángulos

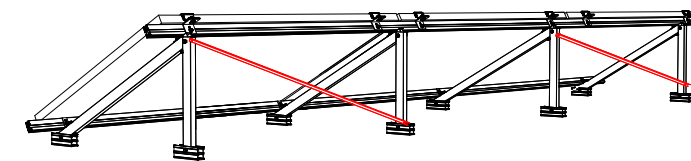

Arriostramiento ≥4 triángulos

1

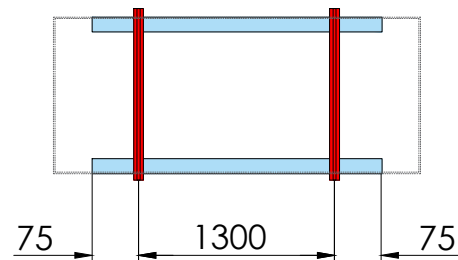

2

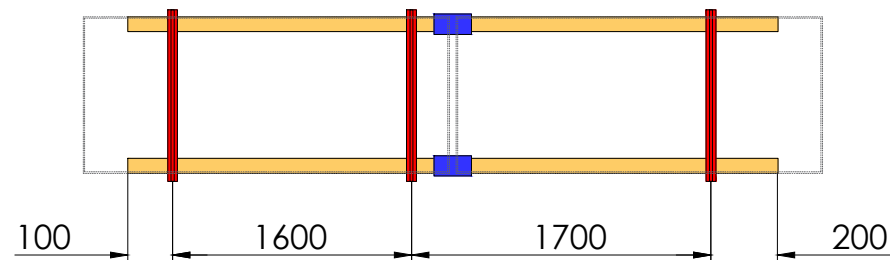

3

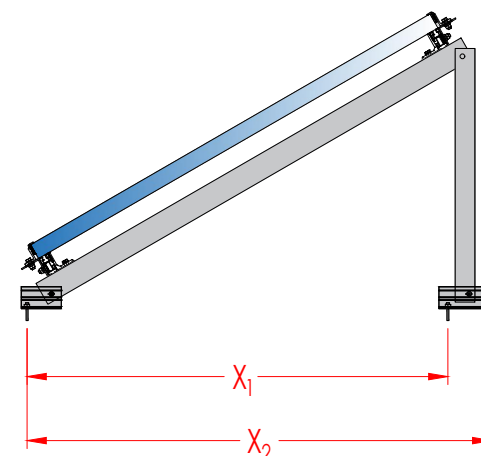
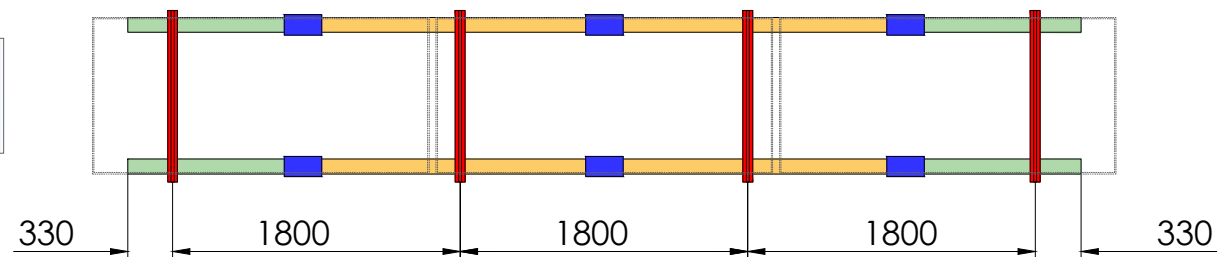

INCLINACIÓN	Distancia anclajes	
	15°	30°
X <sub>1</sub>	1164	1045
X <sub>2</sub>	1264	1145

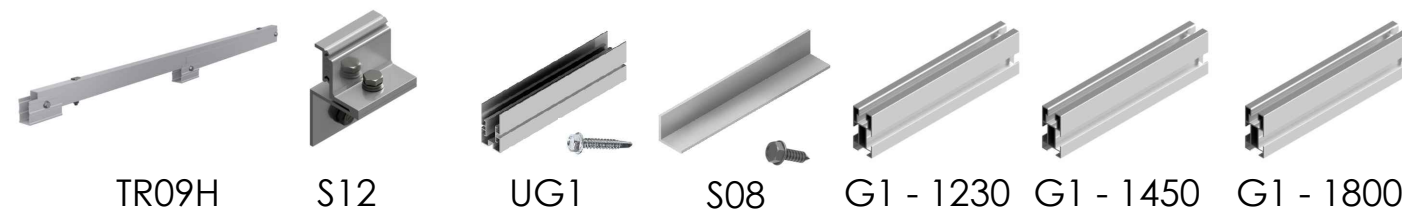

	TR09H	S12	UG1	S08	G1 - 1230	G1 - 1450	G1 - 1800
09H1	2	4	-	1	-	2	-
09H2	3	8	2	2	-	-	4
09H3	4	12	6	2	4	-	4

CARACTERÍSTICAS DEL MONTAJE

